

DS-2XS2T41G1-ID/4G

4 MP Solar-powered Security Camera Setup



- High quality imaging with 4 MP resolution
- Standalone with solar panel and built-in battery
- Support human and vehicle detection
- Provide real-time security via built-in two-way audio
- Water and dust resistant (IP67)
- Support 4G (LTE-TDD/LTE-FDD/TD-SCDMA) communication

▪ Specification

Camera	
Image Sensor	1/3" Progressive Scan CMOS
Max. Resolution	2560 × 1440
Min. Illumination	B/W: 0.01 Lux @ (F1.6, AGC ON), B/W: 0 Lux with IR
Shutter Time	1/3 s to 1/100,000 s
Day & Night	IR cut filter
Angle Adjustment	Solar panel: tilt: -45° to 45°, rotate:-30° to 30°
Lens	
Lens Type	Fixed focal lens, 4 and 6 mm optional
Iris Type	Fixed
Aperture	4mm: F1.28, 6mm: F1.6
Depth of Field	4 mm: 2.7 m to ∞ 6 mm: 5.9 m to ∞
Focal Length & FOV	4 mm, Horizontal FOV: 79°, Vertical FOV: 43°, Diagonal FOV: 93° 6 mm, Horizontal FOV: 49°, Vertical FOV: 26°, Diagonal FOV: 57°
Lens Mount	M12
DORI	
DORI	4 mm, D: 77 m, O: 30 m, R: 15 m, I: 7 m 6 mm, D: 128 m, O: 50 m, R: 25 m, I: 12 m
Illuminator	
Supplement Light Type	IR
Supplement Light Range	Performance mode: up to 30 m, proactive mode: up to 10 m
IR Wavelength	850 nm
Smart Supplement Light	Yes
Video	
Main Stream	50 Hz: 12.5 fps (2560 × 1440, 1920 × 1080, 1280 × 720) 60 Hz: 15 fps (2560 × 1440, 1920 × 1080, 1280 × 720)
Sub-Stream	50 Hz: 12.5 fps (1280 × 720, 640 × 480, 640 × 360) 60 Hz: 15 fps (1280 × 720, 640 × 480, 640 × 360)
Video Compression	Main stream: H.265/ H.264, Sub-stream: H.265/H.264/MJPEG, H.264+ and H.265+: main stream supports under performance mode
Video Bit Rate	32 Kbps to 8 Mbps
H.264 Type	Baseline Profile, Main Profile, High Profile
H.265 Type	Main Profile
Bit Rate Control	CBR, VBR
Region of Interest (ROI)	1 fixed region for main stream
Scalable Video Coding (SVC)	H.264 and H.265 encoding
Audio	
Audio Sampling Rate	8 kHz/16 kHz
Environment Noise Filtering	Yes
Audio Compression	G.711ulaw/G.711alaw/G.722.1/G.726/MP2L2/PCM/AAC-LC
Audio Bit Rate	64 Kbps (G.711ulaw/G.711alaw)/16 Kbps (G.722.1)/16 Kbps (G.726)/32 to 192 Kbps (MP2L2)/8 to 320 Kbps (MP3)/16 to 64 Kbps (AAC-LC)

Network	
Security	Password protection, complicated password, basic and digest authentication for HTTP, TLS 1.1/1.2/1.3, WSSE and digest authentication for Open Network Video Interface
Simultaneous Live View	Up to 6 channels
API	Open Network Video Interface (Profile S, Profile G, Profile T), ISAPI, SDK
Protocols	TCP/IP, ICMP, HTTP, DHCP, DNS, RTP, RTSP, RTCP, NTP, IGMP, QoS, UDP
User/Host	Up to 32 users 3 user levels: administrator, operator, and user
Network Storage	Auto Network Replenishment (ANR)
Client	iVMS-4200, Hik-Connect, Hik-Central
Web Browser	Plug-in required live view: IE 10, IE 11, Plug-in free live view: Chrome 57.0+, Firefox 52.0+, Local service: Chrome 57.0+, Firefox 52.0+
Mobile Communication	
SIM Card Type	Micro SIM
Uplink and Downlink Data Rate	Cat 4, uplink: 50 Mbps, downlink: 150 Mbps
Frequency	EU: LTE-TDD: B38/B40/B41 LTE-FDD: B1/B3/B5/B7/B8/B20/B28 WCDMA: B1/B5/B8 GSM: B3/B5/B8 LA: LTE-TDD: B38/B40 LTE-FDD: B1/B2/B3/B4/B5/B7/B8/B12/B17/B28/B66 WCDMA: B1/B2/B3/B4/B5/B8 GSM: B2/B3/B5/B8
Standard	LTE-TDD, LTE-FDD, WCDMA, GSM
Image	
SNR	≥ 52 dB
Wide Dynamic Range (WDR)	Digital WDR
Day/Night Switch	Day, Night, Auto, Schedule
Image Enhancement	BLC, HLC, 3D DNR
Image Settings	Saturation, brightness, contrast, sharpness, gain, white balance, adjustable by client software or web browser
Transducer	
Transducer Type	PIR + Radar
Detection Angle	4 mm : Horizontal: 80°, vertical: 42°, 6 mm : Horizontal: 50°, vertical: 22°
Detection Range	Up to 12 m
Interface	
Ethernet Interface	1 RJ45 10 M/100 M self-adaptive Ethernet port
On-Board Storage	Built-in eMMC storage, up to 8 GB, Built-in memory card slot, support microSD/microSDHC/microSDXC card, up to 256 GB, For eMMC storage, 5 GB is available for recording.
Built-in Microphone	Yes
Built-in Speaker	Yes

Reset Key	Yes
Event	
Basic Event	Motion detection, video tampering alarm, network disconnected, IP address conflict, illegal login, HDD full, HDD error
Linkage	Upload to NAS/memory card, notify surveillance center, trigger recording, trigger capture, audible warning
General	
Power	<p>Power Consumption and Current: Typical power scenarios: 1.85 W (4G working) Standby scenarios: 70 mW Max. power consumption: 7 W</p> <p>Power Supply: 12 VDC *For debugging only 6.5 W (deviation: ± 1 W) Solar panels</p> <p>Power Interface: Power supply interface: Ø5.5 mm coaxial power plug Extended solar panel: Ø5.5 mm coaxial power plug</p>
Material	Plastic
Storage Conditions	0 °C to 50 °C (32 °F to 122 °F). Humidity 95% or less (non-condensing)
Language	33 languages: English, Russian, Estonian, Bulgarian, Hungarian, Greek, German, Italian, Czech, Slovak, French, Polish, Dutch, Portuguese, Spanish, Romanian, Danish, Swedish, Norwegian, Finnish, Croatian, Slovenian, Serbian, Turkish, Korean, Traditional Chinese, Thai, Vietnamese, Japanese, Latvian, Lithuanian, Portuguese (Brazil), Ukrainian
General Function	Heartbeat, mirror, flash log
Startup and Operating Conditions	0 °C to 50 °C (32 °F to 122 °F). Humidity 95% or less (non-condensing)
Dimension	213.7 mm × 292.4 mm × 188.7 mm (8.4" × 11.5" × 7.3")
Package Dimension	345 mm × 240 mm × 292 mm (13.6" × 9.4" × 11.5")
Weight	Approx. 1.42 kg (3.1 lb.)
With Package Weight	Approx. 2.07 kg (4.6 lb.)
Battery	
Battery Type	Ternary Lithium
Max. Charging Voltage	12.6 V
Capacity	51.46 Wh
Operating Temperature	Charging: 0 °C to 45 °C (32 °F to 113 °F) Discharging: -20 °C to 50 °C (-4 °F to 122 °F)
Battery Voltage	8.1 V to 12.6 V
Cycle Lifetime	Proactive mode: 1.5 days, Standby mode: 11 days
Battery Life	More than 800 cycles
Battery Weight	Approx. 185 g (0.4 lb.)
Approval	
RF	CE-RED: EN 301489-1 V2.1.1 (BT or 2.4G), EN 301489-17 V3.1.1 (BT or 2.4G), EN 300328 V2.1.1 (BT or 2.4G), EN 62311: 2008 (BT or 2.4G) *CE certification is only for the device sold in the European region.

EMC	CE-EMC: EN 55032: 2015, EN 61000-3-2:2019, EN 61000-3-3: 2013+A1:2019, EN 50130-4: 2011 +A1: 2014, RCM: AS/NZS CISPR 32: 2015, *CE and RCM certifications are only for the device sold in the European region.
Safety	CB: IEC 62368-1: 2014+A11, CE-LVD: EN 62368-1: 2014/A11: 2017, LOA: IEC/EN 60950-1, *CE and LOA certifications are only for the device sold in the European region.
Environment	CE-RoHS: 2011/65/EU, WEEE: 2012/19/EU, Reach: Regulation (EC) No 1907/2006, *CE certification is only for the device sold in the European region.
Protection	IP67: IEC 60529-2013

▪ Typical Application

Hikvision products are classified into three levels according to their anti-corrosion performance. Refer to the following description to choose for your using environment.

This model has NO SPECIFIC PROTECTION.

Level	Description
Top-level protection	Hikvision products at this level are equipped for use in areas where professional anti-corrosion protection is a must. Typical application scenarios include coastlines, docks, chemical plants, and more.
Moderate protection	Hikvision products at this level are equipped for use in areas with moderate anti-corrosion demands. Typical application scenarios include coastal areas about 2 kilometers (1.24 miles) away from coastlines, as well as areas affected by acid rain.
No specific protection	Hikvision products at this level are equipped for use in areas where no specific anti-corrosion protection is needed.

▪ Available Model

DS-2XS2T41G1-ID/4G/C05S07 (4/6 mm)

▪ **Dimension**

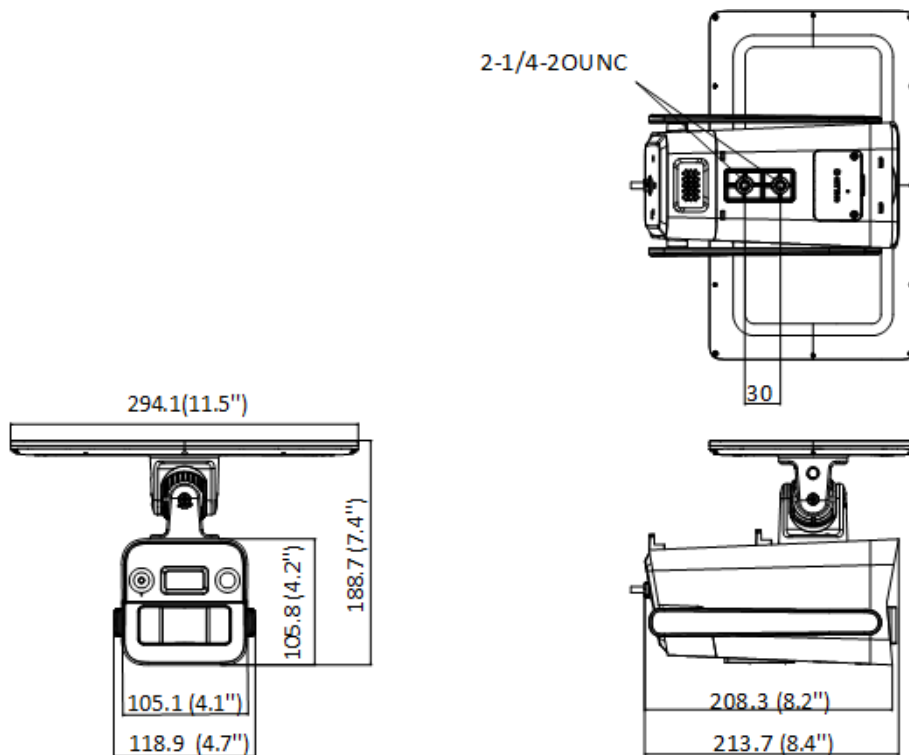

Unit: mm (inch)

Headquarters

No.555 Qianmo Road, Binjiang District,
Hangzhou 310051, China
T +86-571-8807-5998
www.hikvision.com



Follow us on social media to get the latest product and solution information.

