

DS-2CV2121G2-IDW (W) 2 MP EXIR Fixed Dome Network Camera



- Realizing Wi-Fi connection and easy installation
- Provides real-time security via built-in two-way audio
- EXIR 2.0, advanced infrared technology with long IR distance
- Water and dust resistant (IP66)
- Built-in memory card slot, support microSD/microSDHC/microSDXC card, up to 512 GB

▪ Specification

Camera	
Image Sensor	1/2.8" Progressive Scan CMOS
Min. Illumination	Color: 0.005 Lux @ (F1.6, AGC ON), B/W: 0 Lux with IR
Max. Resolution	1920 × 1080
Shutter Time	1/3 s to 1/100,000 s
Day & Night	IR cut filter
Lens	
Lens Type	Fixed focal lens, 2.8 mm and 4 mm optional
Focal Length & FOV	2.8 mm, horizontal FOV 92°, vertical FOV 50°, diagonal FOV 110° 4 mm, horizontal FOV 75°, vertical FOV 41°, diagonal FOV 89°
Aperture	F1.6
Lens Mount	M12
Iris Type	Fixed
Depth of Field	2.8 mm: 1.5 m to ∞ 4 mm: 2 m to ∞
DORI	
DORI	2.8 mm, D: 42 m, O: 17 m, R: 9 m, I: 4 m 4 mm, D: 52 m, O: 21 m, R: 11 m, I: 5 m
Illuminator	
Supplement Light Type	IR
Supplement Light Range	Up to 30 m
Smart Supplement Light	Yes
IR Wavelength	850 nm
Video	
Main Stream	50 Hz: 25 fps (1920 × 1080, 1280 × 720) 60 Hz: 30 fps (1920 × 1080, 1280 × 720)
Sub-Stream	50 Hz: 25 fps (768 × 432, 512 × 288) 60 Hz: 30 fps (768 × 432, 512 × 288)
Video Compression	Main stream: H.264 Sub-stream: H.264
Video Bit Rate	up to 1 Mbps
H.264 Type	Baseline Profile/Main Profile/High Profile
Audio	
Audio Compression	G.711/AAC-LC
Audio Bit Rate	64 Kbps (G.711)/16 to 64 Kbps (AAC-LC)
Audio Sampling Rate	8 kHz/16 kHz
Environment Noise Filtering	Yes
Network	
Protocols	TCP/IP, ICMP, HTTP, HTTPS, FTP, DHCP, DNS, RTP, RTSP, RTCP, NTP, UPnP, IGMP, QoS, IPv4, UDP, Bonjour, SSL/TLS
Simultaneous Live View	Up to 4 channels
API	ONVIF, SDK
User/Host	administrator
Security	Password protection, HTTPS encryption, Security Audit Log, basic and digest authentication for HTTP/HTTPS, TLS 1.1/1.2, WSSE for Open Network Video Interface

Client	iVMS-4200, Hik-Connect, Hik-Partner-Pro
Wi-Fi	
Wi-Fi Protocol	IEEE802.11b, 802.11g, 802.11n
Frequency Range	2.412 GHz to 2.472 GHz
Channel Bandwidth	20 MHz
Modulation	802.11b: CCK, QPSK, BPSK, 802.11g: OFDM, 802.11n: OFDM
Transfer Rate	11b: up to 54 Mbps, 11g: up to 54 Mbps, 11n: up to up to 150 Mbps
Wireless Range	Up to 120 m (The performance varies based on actual environment)
Antenna	2 Antenna(s)
Image	
Image Settings	Rotate mode, saturation, brightness, contrast, sharpness adjustable by client software
Day/Night Switch	Auto, Schedule, Day, Night
Wide Dynamic Range (WDR)	Digital WDR
Privacy Mask	4 programmable polygon privacy masks
Interface	
Built-in Microphone	Yes, 1 built-in microphone
Built-in Speaker	Yes, 1 built-in microphone
On-Board Storage	Built-in memory card slot, support microSD/microSDHC/microSDXC card, up to 512 GB
Reset Key	Yes
Ethernet Interface	1 RJ45 10 M/100 M self-adaptive Ethernet port
Event	
Basic Event	Motion detection (support alarm triggering by specified target types (human and vehicle)), exception
Linkage	Upload to memory card, notify surveillance center, trigger capture, audible warning, auto-tracking lite
General	
Power	12 VDC \pm 10%, 1A, max. 10 W, \varnothing 2 mm coaxial power plug, reverse polarity protection
Storage Conditions	-30 °C to 60 °C (-22 °F to 140 °F). Humidity 95% or less (non-condensing)
Startup and Operating Conditions	-30 °C to 60 °C (-22 °F to 140 °F). Humidity 95% or less (non-condensing)
General Function	Heartbeat, mirror
Material	Base: metal, front cover: polycarbonate, back cover: polycarbonate
Dimension	120 mm \times 120 mm \times 95 mm (4.7" \times 4.7" \times 3.7")
Package Dimension	170 mm \times 170 mm \times 150 mm (6.7" \times 6.7" \times 5.9")
Weight	Approx. 593 g (1.3 lb.)
With Package Weight	Approx. 886 g (1.95 lb.)
Approval	
EMC	CE-EMC: EN 55032: 2015, EN 61000-3-2:2019, EN 61000-3-3: 2013+A1:2019, EN 50130-4: 2011 +A1: 2014
RF	CE-RED (EN 301489-1 V2.1.1(BT or 2.4G); EN 301489-17 V3.1.1(BT or 2.4G); EN 300328 V2.1.1(BT or 2.4G); EN 62311:2008(BT or 2.4G));

Safety	CB: IEC 62368-1: 2014+A11, CE-LVD: EN 62368-1: 2014/A11: 2017
Environment	CE-RoHS: 2011/65/EU WEEE: 2012/19/EU
Protection	IP66: IEC 60529-2013

▪ Typical Application

Hikvision products are classified into three levels according to their anti-corrosion performance. Refer to the following description to choose for your using environment.

This model has NO SPECIFIC PROTECTION.

Level	Description
Top-level protection	Hikvision products at this level are equipped for use in areas where professional anti-corrosion protection is a must. Typical application scenarios include coastlines, docks, chemical plants, and more.
Moderate protection	Hikvision products at this level are equipped for use in areas with moderate anti-corrosion demands. Typical application scenarios include coastal areas about 2 kilometers (1.24 miles) away from coastlines, as well as areas affected by acid rain.
No specific protection	Hikvision products at this level are equipped for use in areas where no specific anti-corrosion protection is needed.

▪ Available Model

DS-2CV2121G2-IDW(2.8mm)(W)

DS-2CV2121G2-IDW(4mm)(W)

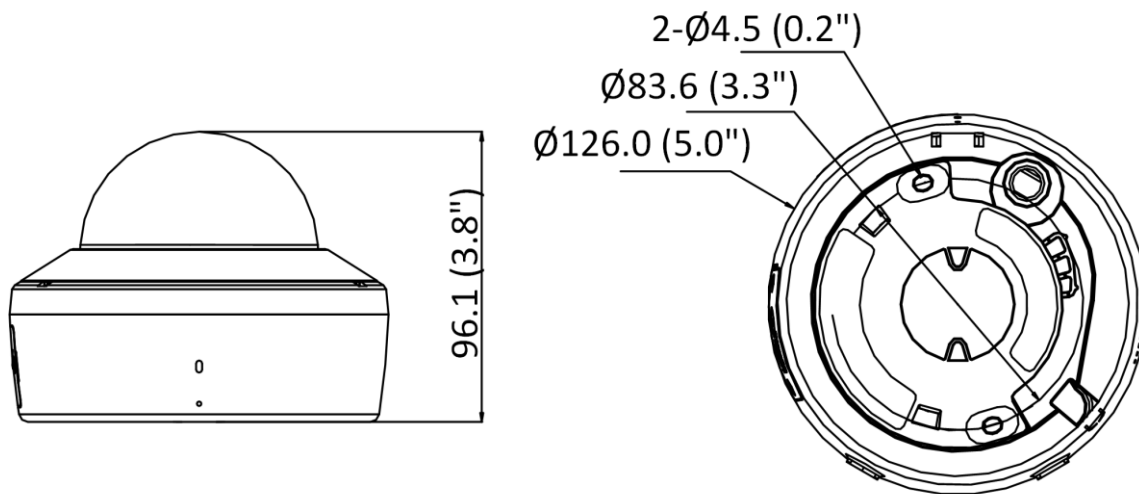

▪ **Dimension**



Unit: mm (inch)

▪ **Accessory**

▪ **Optional**

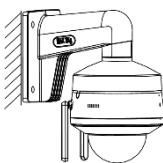
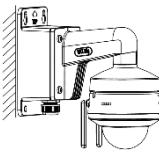
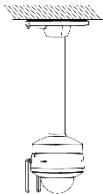
DS-1272ZJ-120 Wall mount	DS-1272ZJ-120B Wall mount	DS-1271ZJ-120 Pendant Mount
		
		

Headquarters

No.555 Qianmo Road, Binjiang District,
Hangzhou 310051, China
T +86-571-8807-5998
www.hikvision.com



Follow us on social media to get the latest product and solution information.

